

Anexa nr. 2

**INDICATOARE RUTIERE**

**A. INDICATOARE DE AVERTIZARE**



Curbă la stânga



Curbă la dreapta



Curbă dublă sau o succesiune de mai mult de două curbe, prima la stânga



Curbă dublă sau o succesiune de mai mult de două curbe, prima la dreapta



Curbă deosebit de periculoasă



Panouri succesive pentru curbe deosebit de periculoase



Coborâre periculoasă



Urcare cu înclinare mare



Drum îngustat pe ambele părți



Drum îngustat pe partea dreaptă



Drum îngustat pe partea stângă



Acostament periculos



# E-JURIDIC



Drum aglomerat



Tunel



Pod mobil



Ieșire spre un chei sau mal abrupt



Drum cu denivelari



Denivelare pentru limitarea vitezei



Drum lunecos



Improșcare cu pietriș



Căderi de pietre



Presemnalizare trecere pietoni



Copii



Bicicliști



Animale



Animale



Lucrări



# E-JURIDIC



Semafoare



Acroport



Vânt lateral



Circulație în ambele sensuri



Alte pericole



Accident



Intersecție de drumuri



Intersecție cu un drum fără prioritate



Intersecție cu un drum fără prioritate



Intersecție cu un drum fără prioritate



Intersecții cu drumuri fără prioritate, decalate



Intersecții cu drumuri fără prioritate, decalate



Presemnalizare intersecție cu sens giratoriu



Trecere la nivel cu o cale ferată cu bariere sau semibariere



Trecere la nivel cu o cale ferată fără bariere



# E-JURIDIC



Trecere la nivel cu linii de tramvai



Mașini și utilaje agricole



Presemnalizarea unei amenajări rutiere care oferă și posibilitatea întoarcerii vehiculelor



Baliză direcțională care indică ocolirea obstacolului prin stânga



Baliză direcțională care indică ocolirea obstacolului prin dreapta



Baliză bidirecțională

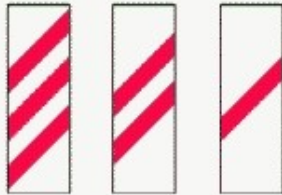

Panouri suplimentare pentru trecerea la nivel cu calea ferată



Panouri suplimentare la nodurile rutiere de pe autostrăzi



Trecere la nivel cu o cale ferată simplă, fără bariere



Trecere la nivel cu o cale ferată dublă, fără bariere



Trecere la nivel cu o cale ferată simplă fără bariere



Trecere la nivel cu o cale ferată dublă fără bariere



# E-JURIDIC

## B. INDICATOARE DE REGLEMENTARE

### B1. Indicatoare de prioritate



Cedează trecerea



Oprește

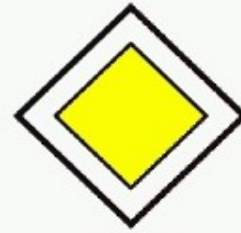

Drum cu prioritate



Sfârșitul drumului cu prioritate



Prioritate pentru circulația din sens invers

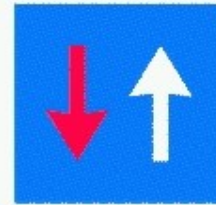

Prioritate față de circulația din sens invers

### B2. Indicatoare de interzicere sau restricție



Accesul interzis



Circulația interzisă în ambele sensuri



Accesul interzis autovehiculelor cu excepția motocicletelor fără ataș



# E-JURIDIC



Accesul interzis motocicletelor



Accesul interzis bicicletelor



Accesul interzis ciclomotoarelor



Accesul interzis vehiculelor  
destinate transportului de mărfuri



Accesul interzis autovehiculelor cu  
remorcă, cu excepția celor cu  
semiremorcă sau cu remorcă cu o osie



Accesul interzis autobuzelor



Accesul interzis pietonilor



Accesul interzis vehiculelor  
cu tracțiune animală



Accesul interzis vehiculelor  
împinse sau trase cu mâna



Accesul interzis tractoarelor și mașinilor  
autopropulsate pentru lucrări



Accesul interzis autovehiculelor



Accesul interzis autovehiculelor și  
vehiculelor cu tracțiune animală



Accesul interzis vehiculelor  
cu lățimea mai mare de ... m



Accesul interzis vehiculelor  
cu înălțimea mai mare de ... m



Accesul interzis vehiculelor  
cu masa mai mare de ... t



# E-JURIDIC



Accesul interzis vehiculelor cu masa mai mare de ... t pe osia simplă



Accesul interzis vehiculelor cu masa pe osia dublă mai mare de ... t



Accesul interzis vehiculelor cu masa pe osia triplă mai mare de ... t



Accesul interzis autovehiculelor sau ansamblurilor de vehicule cu lungimea mai mare de ... m



Interzis autovehiculelor de a circula fără a menține între ele un interval de cel puțin ... m



Interzis a vira la stânga



Interzis a vira la dreapta



Întoarcerea interzisă



Depășirea autovehiculelor, cu excepția motocicletelor fără ataș, interzisă



Depășirea interzisă autovehiculelor destinate transportului de mărfuri



Limitare de viteză



Limitare de viteză diferențiată pe categorii de autovehicule



Claxonarea interzisă

















Vama



Taxă de trecere



# E-JURIDIC

 <p>Control POLIȚIE</p>	 <p>Sfârșitul tuturor restricțiilor</p>	 <p>Sfârșitul limitării de viteză</p>
 <p>Sfârșitul interzicerii de a depăși</p>	 <p>Staționarea interzisă</p>	 <p>Oprirea interzisă</p>
 <p>Staționare alternantă</p>	 <p>Staționare alternantă</p>	 <p>Zona de staționare cu durată limitată</p>
 <p>Sfârșitul zonei de staționare cu durată limitată</p>	 <p>Zonă cu viteză limitată la 30 km/h</p>	 <p>Sfârșitul zonei cu viteză limitată la 30 km/h</p>
 <p>Accesul interzis vehiculelor care transportă substanțe explozive sau ușor inflamabile</p>	 <p>Accesul interzis vehiculelor care transportă mărfuri periculoase</p>	 <p>Accesul interzis vehiculelor care transportă substanțe de natură să polueze apele</p>





# E-JURIDIC

## B3. Indicatoare de obligare



Înainte



La dreapta



La dreapta



Înainte sau la dreapta



Ocolire



Ocolire



Intersecție cu sens giratoriu



Pistă pentru biciclete



Drum obligatoriu pentru categoria de vehicule



Drum pentru pietoni



Delimitarea pistelor pentru pietoni și biciclete



Delimitarea pistelor pentru pietoni și biciclete



# E-JURIDIC



Pistă comună pentru pietoni și biciclete



Viteza minimă obligatorie



Sfârșitul vitezei minime obligatorii



Lanțuri pentru zăpadă

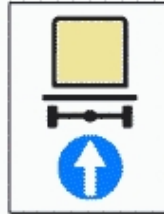

Direcția obligatorie pentru vehiculele care transportă mărfuri periculoase

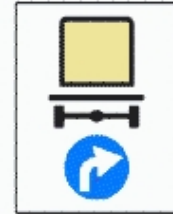

Direcția obligatorie pentru vehiculele care transportă mărfuri periculoase

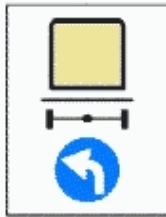

Direcția obligatorie pentru vehiculele care transportă mărfuri periculoase

## C. INDICATOARE DE ORIENTARE ȘI INFORMARE

### C1. Indicatoare de orientare



Presemnalizarea direcțiilor la o intersecție de drumuri din afara localităților



Presemnalizarea direcțiilor la o intersecție denivelată de drumuri



Presemnalizarea direcțiilor indicate



Presemnalizarea traseului de evitare a localității



Presemnalizarea direcțiilor într-o intersecție cu sens giratoriu



Drum închis sau deschis circulației publice



Presemnalizarea traseului de urmat în cazul unei restricții de circulație



Presemnalizare pe autostradă pentru parcare



Presemnalizare pe autostradă pentru spațiu de servicii



Confirmarea direcției de mers pe autostradă spre localități mai importante și distanțele până la acestea



Presemnalizarea unui loc periculos, o interdicție sau o restricție pe un drum lateral

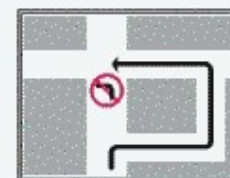

Presemnalizarea traseului de urmat în vederea efectuării virajului la stânga



# E-JURIDIC

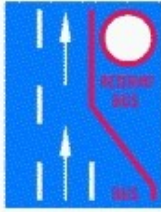

Bandă rezervată circulației autovehiculelor de transport public de persoane



Drum fără ieșire



Traseu de urmat pentru anumite categorii de vehicule



Traseu de urmat pentru anumite categorii de vehicule



Traseu de urmat pentru anumite categorii de vehicule



Selectarea circulației pe direcții de mers în apropierea intersecției



Selectarea circulației pe direcții de mers în apropierea intersecției



Selectarea circulației pe direcții de mers în apropierea intersecției



Bandă destinată circulației vehiculelor lente



Terminarea benzii de circulație din dreapta a părții carosabile

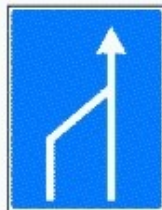

Terminarea benzii de circulație din stânga a părții carosabile



Viteza minimă obligatorie pentru o bandă de circulație

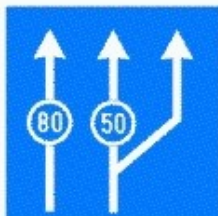

Viteza minimă obligatorie pentru diferite benzi de circulație

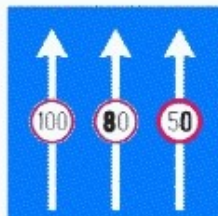

Limite de viteză pentru diferite benzi de circulație

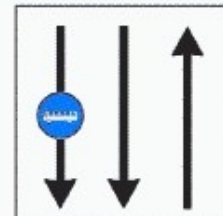

Bandă de circulație rezervată autovehiculelor de transport public de persoane



# E-JURIDIC



Direcția spre localitatea indicată



Direcția spre localitatea indicată



Direcția spre localitățile indicate

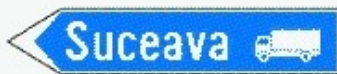

Direcția de urmat pentru autovehiculele destinate transportului de mărfuri



Direcția spre obiectivul turistic



Direcția spre obiective locale

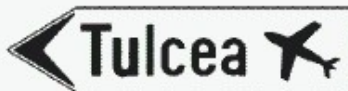

Direcția spre aeroport



Direcția de urmat în cazul devierii temporare a circulației



Direcția de urmat în cazul devierii temporare a circulației



Drum național



Drum județean



Drum comunal



Drum deschis traficului internațional



Direcția drumului deschis traficului internațional



Traseu de tranzit european



# E-JURIDIC



Simbolul și numărul autostrăzii



Intrare în localitate



Intrare în localitate



Ieșire din localitate



Ieșire din localitate



Limită de județ



Curs de apă sau viaduct

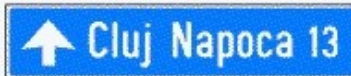

Confirmarea direcției de mers spre o localitate și distanța până la aceasta



Confirmarea direcției de mers spre localități mai importante și distanțele până la acestea



Organizarea traficului pe benzi de circulație



Telefon de urgență (Poliție, Ambulanță, Pompieri, Depanare)



# E-JURIDIC

## C2. Indicatoare de informare



Trecere pentru pietoni



Trecere pentru pietoni



Limite generale de viteză



Sens unic



Sens unic



Autostradă



Sfârșit de autostradă



Limite maxime de viteză pe autostradă,  
funcție de condițiile meteorologice



Spital



Poliția



Post de prim-ajutor



Pasarela pentru pietoni



# E-JURIDIC



Pasaj subteran pentru pietoni



Stație de autobuz



Stație de tramvai



Stație de taximetre



Drum pentru autovehicule



Sfârșitul drumului pentru autovehicule



Vulcanizare



Telefon



Stație de alimentare cu carburanți



Stație de alimentare cu carburanți inclusiv benzină fără plumb



Stație de alimentare cu carburanți inclusiv benzină fără plumb și gaz petrolier lichefiat



Hotel sau motel



Restaurant



Bufet sau cofetărie















Teren pentru camping (tabără turistică)



















# E-JURIDIC

 <p>Teren pentru caravane (tabără turistică)</p>	 <p>Teren pentru camping și caravane</p>	 <p>Loc pentru popas</p>
 <p>Cabană pentru turiști</p>	 <p>W.C. public</p>	 <p>Service auto</p>
 <p>Parcare</p>	 <p>Parcare</p>	 <p>Parcare subterană sau în clădire</p>
 <p>Complex de servicii</p>		 <p>Zonă rezidențială</p>
		 <p>Sfârșitul zonei rezidențiale</p>

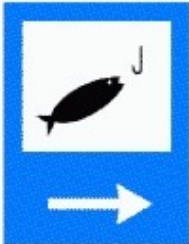

# E-JURIDIC

 <p>Zonă cu viteză recomandată 30 km/h</p>	 <p>Sfârșitul zonei cu viteză recomandată 30 km/h</p>	 <p>Zonă pietonală</p>
 <p>Sfârșitul zonei pietonale</p>	 <p>Tunel</p>	 <p>Sfârșit de tunel</p>
 <p>Îmbarcare pe vagoane platformă de cale ferată</p>	 <p>Îmbarcare pe ferry-boat</p>	 <p>Port</p>
 <p>Gară</p>	 <p>Autogară</p>	 <p>Închirieri auto</p>
 <p>Plajă</p>	 <p>Zonă de vânatoare</p>	 <p>Zonă de pescuit</p>



# E-JURIDIC



Centru viticol



Zonă industrială



Poșta



Apă potabilă



Loc de joacă pentru copii



Stadion



Supermarket



Acces internet

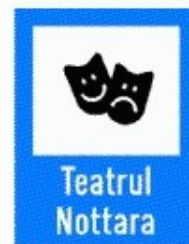

Teatru



Muzeu



Cântar pentru autovehicule



Control radar



Informații rutiere













Viteza recomandată



Punct de informare turistică

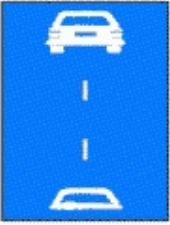

# E-JURIDIC

 <p>Denumirea străzii</p>	 <p>Intrarea pe strada indicată</p>	 <p>Numărul imobilului</p>
 <p>Monitorizare trafic</p>	 <p>Refugiu rezervat depanării</p>	 <p>Presemnalizarea sediului Poliției autostrăzii</p>
 <p>Distanța de siguranță între vehicule pentru viteze de cel mult 60 km/h</p>	 <p>Distanța de siguranță între vehicule pentru viteze mai mari de 60 km/h</p>	 <p>Acces pe bază de tichet</p>
 <p>Direcția și distanța până la telefonul pentru apel de urgență</p>		



# E-JURIDIC

## C3. Indicatoare de informare turistică



Castel, cetate



Vestigii istorice



Monument



Biserică

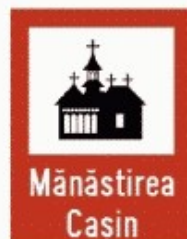

Mănăstire



Rezervație naturală

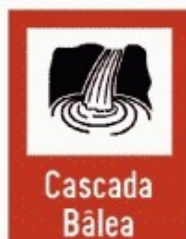

Cascadă



Peșteră



Pârtie schi



Teleschi



Telecabină













Pensiune agroturistică

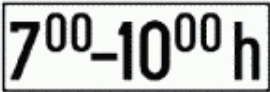

# E-JURIDIC

## D. PANOURI ADIȚIONALE

 <p>Distanța până la locul la care se referă indicatorul de presemnalizare sau informare</p>	 <p>Distanța între indicator și începutul locului periculos</p>	 <p>Direcția și distanța până la locul la care se referă indicatorul</p>
 <p>Persoane cu handicap</p>	 <p>Intervalele de timp în care acționează indicatorul</p>	 <p>Intervalele de timp în care acționează indicatorul</p>
 <p>Trecere la nivel cu cale ferată industrială completând semnificația indicatorului "Alte pericole"</p>	 <p>Lungimea sectorului periculos la care se referă indicatorul</p>	 <p>Începutul și lungimea zonei de acțiune a indicatorului</p>
 <p>Începutul zonei de acțiune a indicatorului</p>	 <p>Confirmarea zonei de acțiune a indicatorului</p>	 <p>Sfârșitul zonei de acțiune a indicatorului</p>



# E-JURIDIC



Categoria de autovehicule la care se referă indicatorul

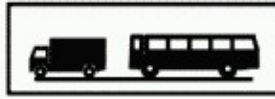

Categoriile de autovehicule care trebuie să respecte semnificația indicatorului



Folosirea luminilor de întâlnire



Parcare cu plată

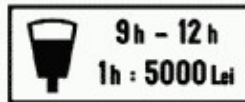

Parcare cu plată

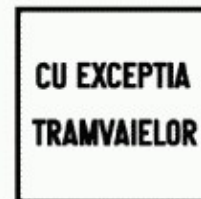

Exceptarea unor categorii de vehicule de la semnificația indicatorului

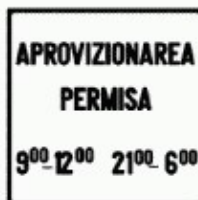

Intervalele de timp când este permisă staționarea vehiculelor ce efectuează aprovizionarea



Drum închis circulației publice



Trecere pentru pietoni desființată



Cu excepția riveranilor

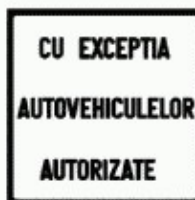

Cu excepția autovehiculelor autorizate



Autovehiculul se ridică

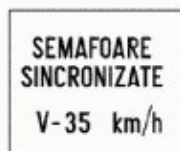

Viteza recomandată pe un sector de drum cu semafoare sincronizate















Direcția drumului cu prioritate

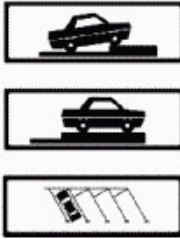

Direcția drumului cu prioritate

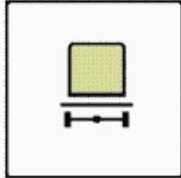
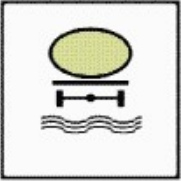

# E-JURIDIC

 <p>Sensul sau sensurile de circulație pentru care este valabilă semnificația semnalelor luminoase ale semaforului</p>	 <p>Trecerea la nivel cu calea ferată prevăzută cu instalație de semnalizare luminoasă automată</p>	 <p>Rampă pentru persoane cu handicap locomotor</p>
 <p>Modalități în care se execută parcare</p>	 <p>Modalități în care se execută parcare</p>	 <p>Ridicarea autovehiculelor parcate neregulamentar</p>
 <p>Folosirea luminilor de întâlnire</p>	 <p>Polei, gheață, zăpadă</p>	 <p>Duș</p>
 <p>Ploaie, ceață, viscol</p>	 <p>Vehicule care transportă substanțe explozive sau ușor inflamabile</p>	 <p>Vehicule care transportă mărfuri periculoase</p>
 <p>Vehicule care transportă substanțe de natură să polueze apele</p>	 <p>Distanța până la indicatorul "Oprire"</p>	 <p>Numărul nodului rutier de pe autostradă</p>





# E-JURIDIC

## DISPOZITIVE DE SEMNALIZARE LUMINOASĂ

### 1. Semafoare pentru dirijarea circulației



Semafor



Semafoare cu indicarea direcției de deplasare

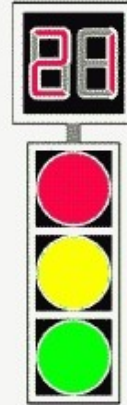

Semafor combinat cu dispozitiv de cronometrare a timpului aferent culorii

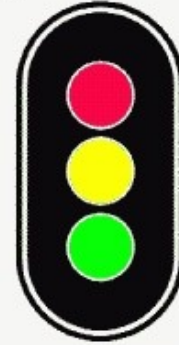

Semafor cu panou de contrast



Semafor pentru biciclete



Semafor pentru pietoni



Semafor pentru pietoni combinat cu dispozitiv de cronometrare a timpului aferent culorii



Semafor de avertizare

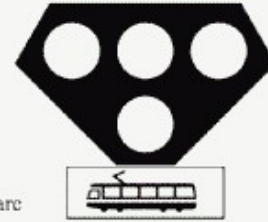

Semafor special pentru tramvaie

### 2. Semnale luminoase la trecerile la nivel cu calea ferată



Trecere la nivel cu o cale ferată simplă, fără bariere, prevăzută cu semnale luminoase de avertizare a apropierii trenului



Trecere la nivel cu o cale ferată dublă, fără bariere, prevăzută cu semnale luminoase de avertizare a apropierii trenului



Trecere la nivel cu o cale ferată simplă cu semibarieră, prevăzută cu semnale luminoase de avertizare a apropierii trenului



# E-JURIDIC

## INDICATOR KILOMETRIC



Autostradă

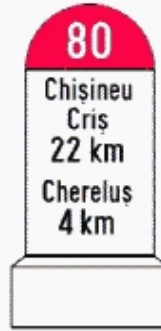

Drum național



Drum județean



Drum comunal

## INDICATOR HECTOMETRIC

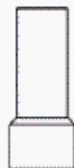



# E-JURIDIC

## INDICATOARE RUTIERE ȘI MIJLOACE DE SEMNALIZARE A LUCRĂRILOR ÎN ZONA DRUMULUI PUBLIC

### 1. Indicatoare rutiere temporare



Drum îngustat pe ambele părți



Drum îngustat pe partea dreaptă



Drum îngustat pe partea stângă



Acostament periculos



Drum cu denivelări



Drum lunecos



Împroșcare cu pietriș



Lucrări



Semafoare



Circulație în ambele sensuri



Alte pericole



Depășirea autovehiculelor, cu excepția motocicletelor fără ataș, interzisă



# E-JURIDIC



Limitare de viteză



Sfârșitul tuturor restricțiilor



Sfârșitul interzicerii de a depăși



Deviere temporară



Deviere temporară



Deviere temporară



Deviere temporară



Denivelare față de banda alăturată



Îngustare temporară



Îngustare temporară



Abateră temporară



Abateră temporară



Abateră temporară



Terminarea abaterii temporare



Îngustare temporară



# E-JURIDIC



Îngustare temporară



Presemnalizarea rutei ocolitoare



Presemnalizarea rutei ocolitoare



Presemnalizarea rutei ocolitoare



Marcaje rutiere



Semnalizarea unui utilaj care se deplasează lucrând



Succesiune de puncte de lucru



Presemnalizarea unui sector cu circulație alternantă



Presemnalizarea unui sector cu circulație alternantă



Lucrări de tratamente ale suprafeței părții carosabile



Presemnalizare lucrări pe străzi



# E-JURIDIC

## 2. Mijloace auxiliare de semnalizare a lucrărilor

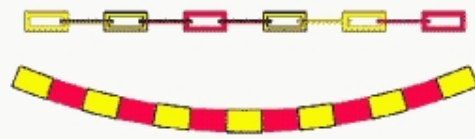

Ghirlandă polietilenă sau lanț

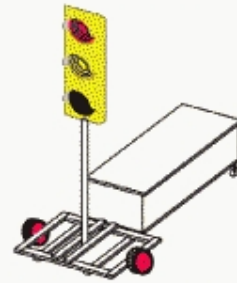

Semafor mobil



Baliză direcțională care indică ocolirea obstacolului prin stânga



Baliză direcțională care indică ocolirea obstacolului prin dreapta

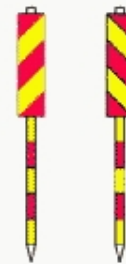

Baliză tip jalon



Baliză bidirecțională



Con de dirijare



Balize cuplate cu lămpi cu lumină galbenă intermitentă



Lampă cu lumină galbenă intermitentă



Barieră normală



Barieră direcțională



# E-JURIDIC

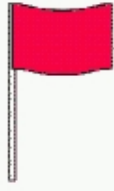

Fanion de semnalizare

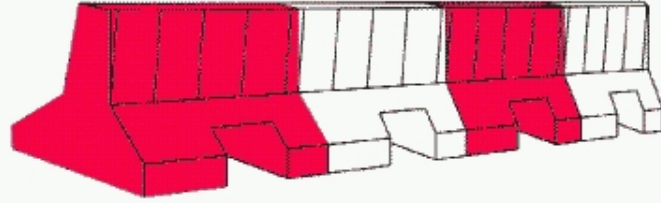

Parapet lestable din material plastic

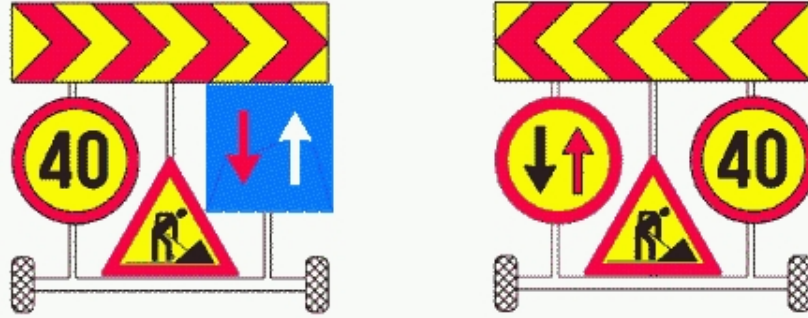

Cărucioare portsemnalizare

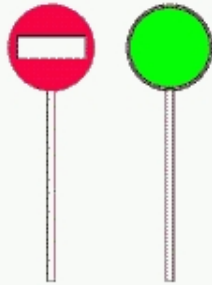

Palete de semnalizare



# E-JURIDIC

## 3. Dispozitive luminoase pentru dirijarea circulației pe benzi

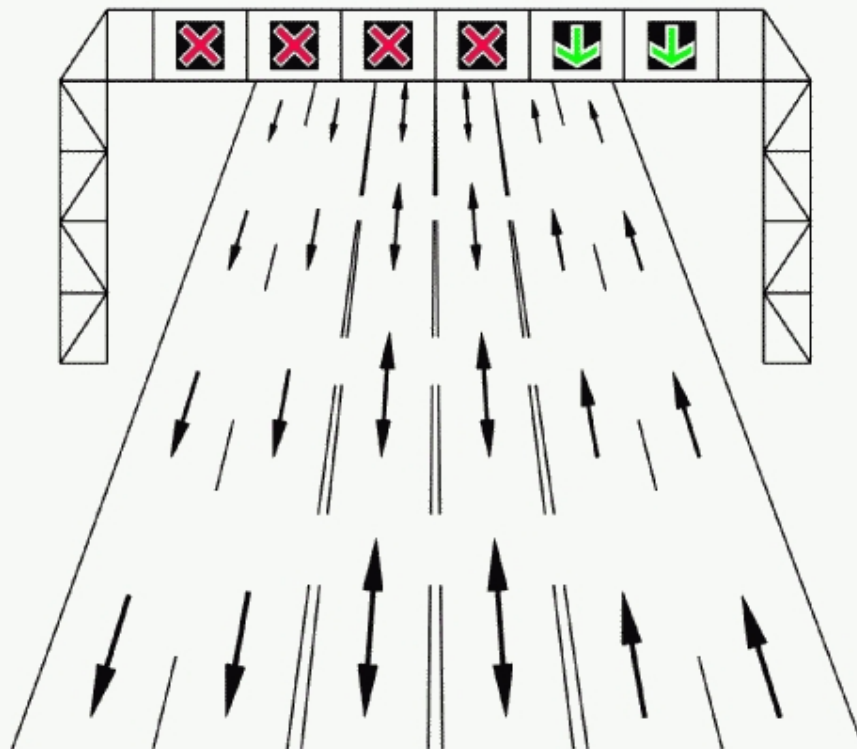
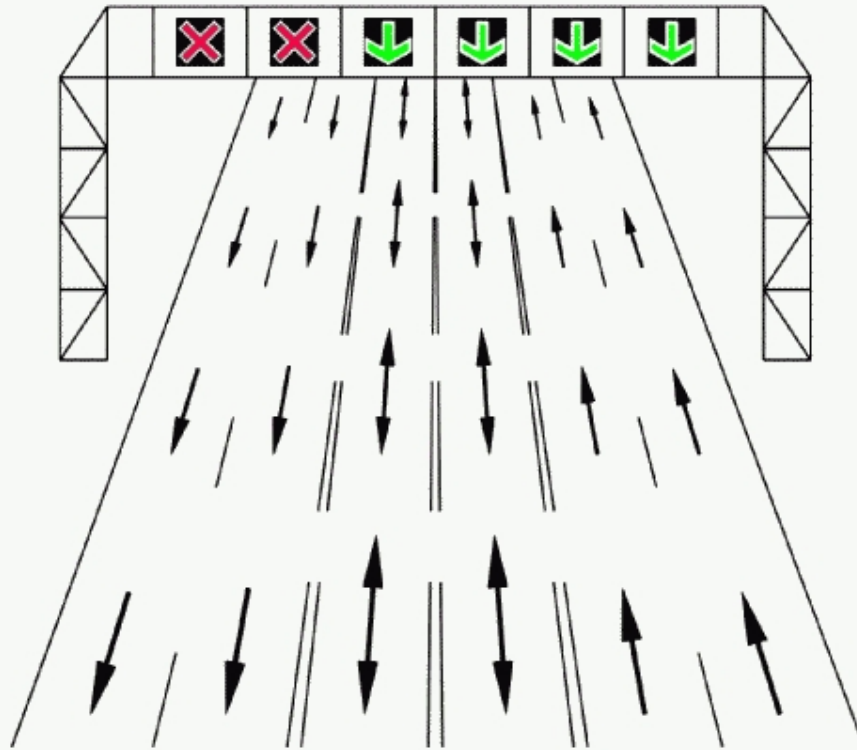

Dispozitive luminoase pentru dirijarea circulației pe benzi reversibile





# E-JURIDIC



Panou cu mesaje variabile



# E-JURIDIC

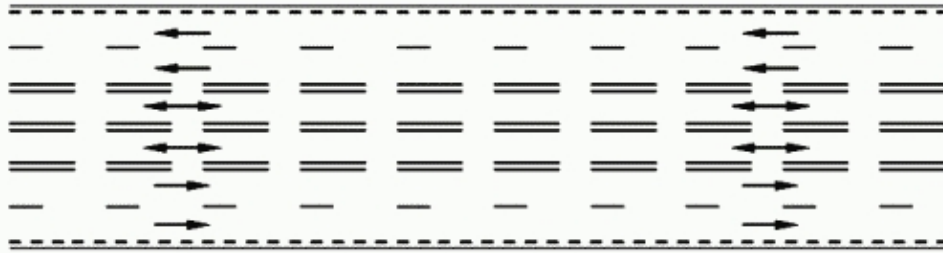

Marcaj pentru benzi cu circulația reversibilă

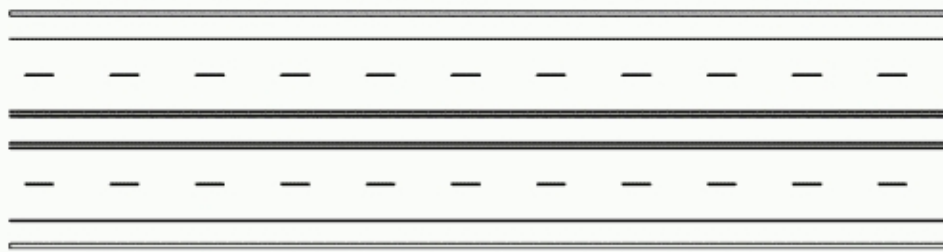

Marcaj pe drumuri cu zona verde de separare a sensurilor de circulație

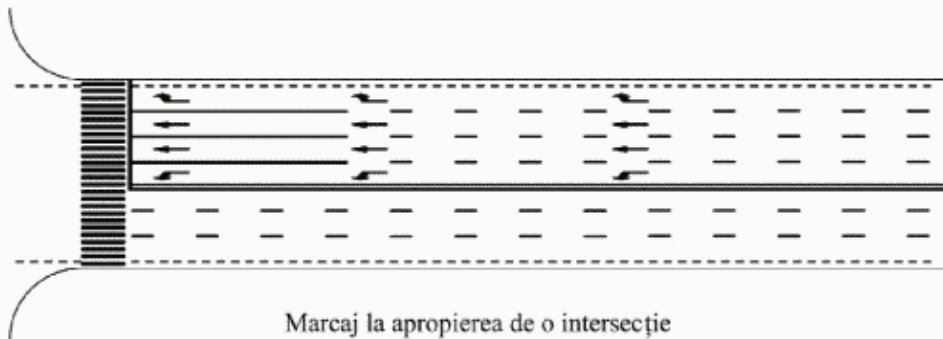

Marcaj la apropierea de o intersecție

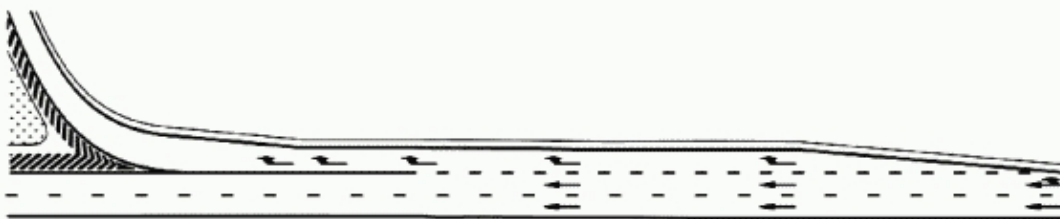

Marcajul pe o bandă de decelerare

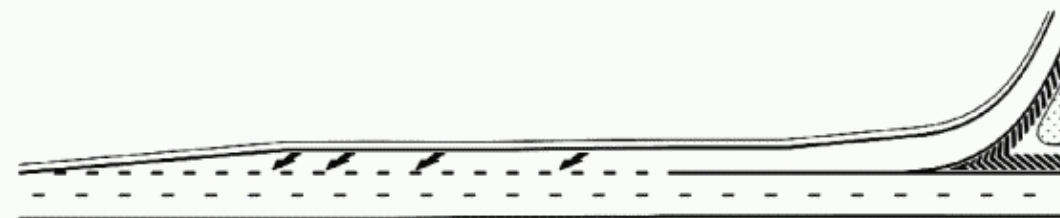

Marcajul pe o bandă de accelerare



# E-JURIDIC

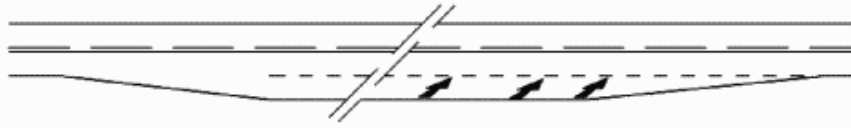

Marcajul benzii suplimentare pentru vehicule lente



Marcajul benzii de stocaj pentru virajul la stânga

## b) Transversale

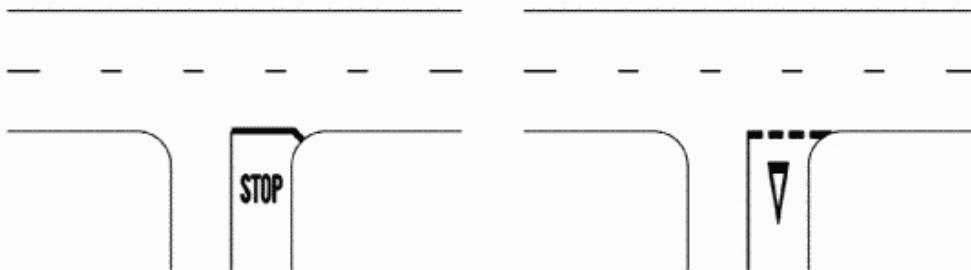

Marcaj de oprire și cedare a trecerii

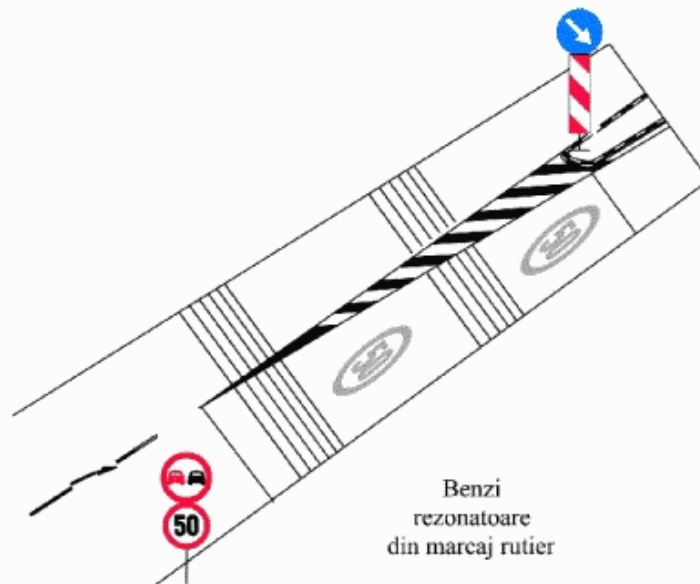

Benzi rezonatoare din marcaj rutier



# E-JURIDIC

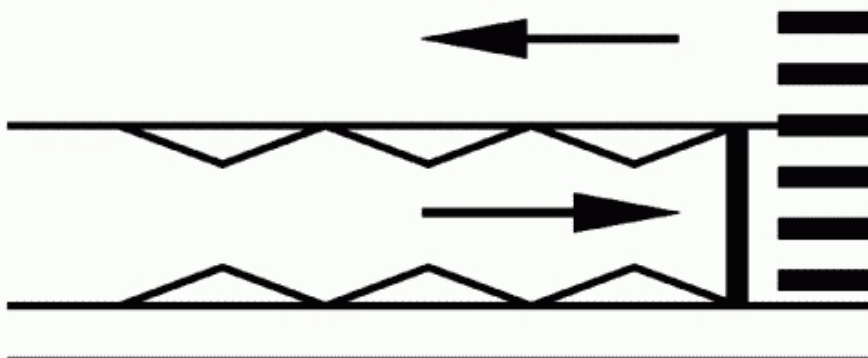
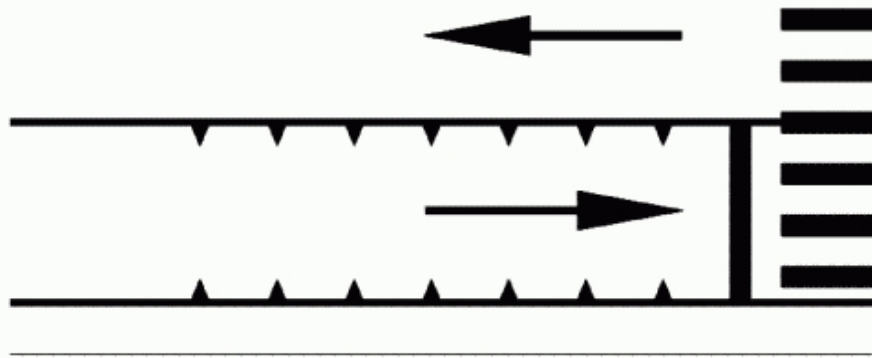

Marcaje de traversare pentru pietoni



# E-JURIDIC

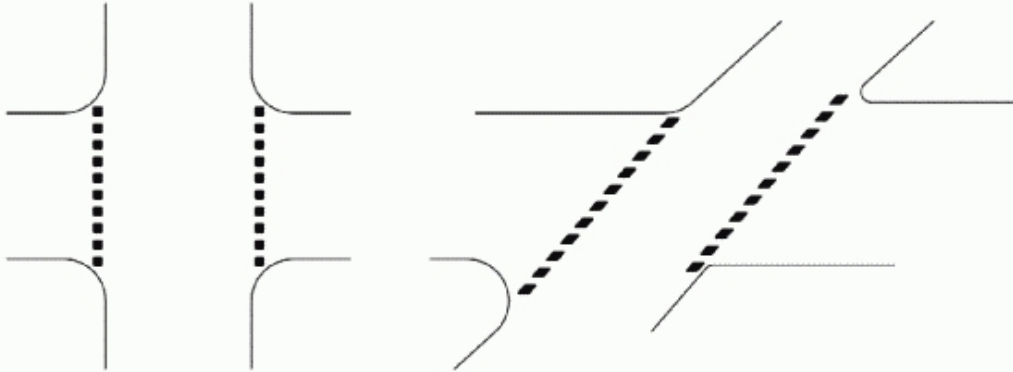

Marcaj de traversare pentru biciclete

## c) Diverse

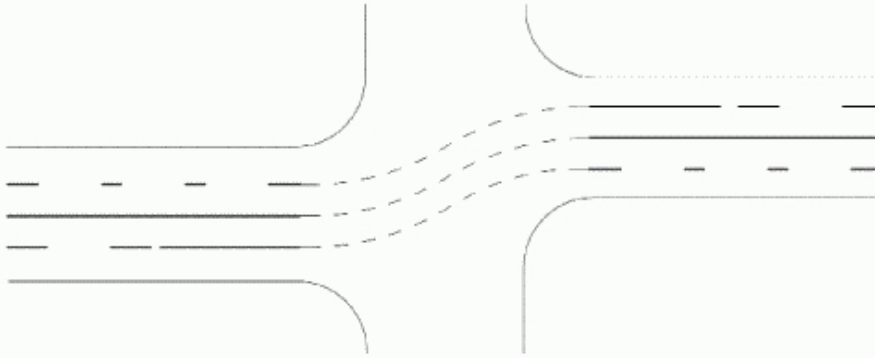

Marcaj de ghidare la traversarea unei intersecții

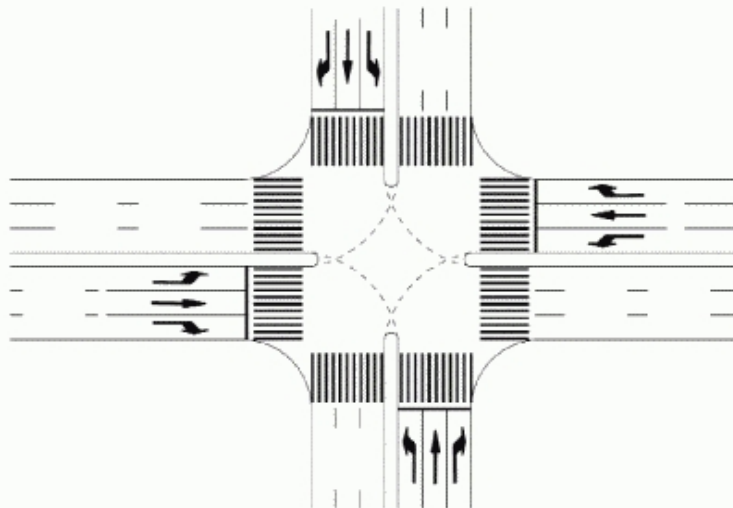

Marcaj de ghidare în intersecție



# E-JURIDIC

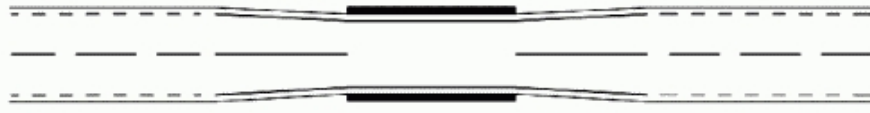

Marcaj pentru spații înguste



Marcaj la îngustarea drumului cu o bandă pe sens



Marcaj pe drum cu trei benzi pentru alocarea alternativă a doua benzi pentru unul sau celălalt sens de circulație



Spații interzise circulației



# E-JURIDIC

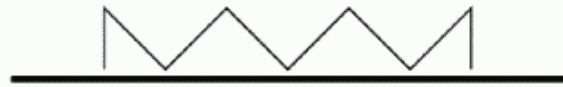

Interzicerea staționării

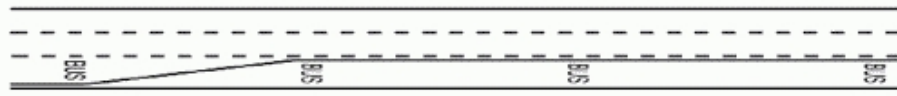

Marcajul benzii rezervate circulației autovehiculelor de transport persoane



Stație autovehicule de transport persoane

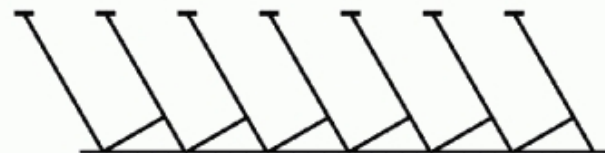
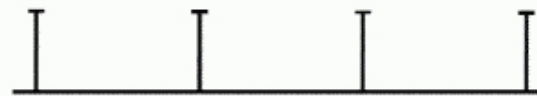

Locuri de parcare



# E-JURIDIC

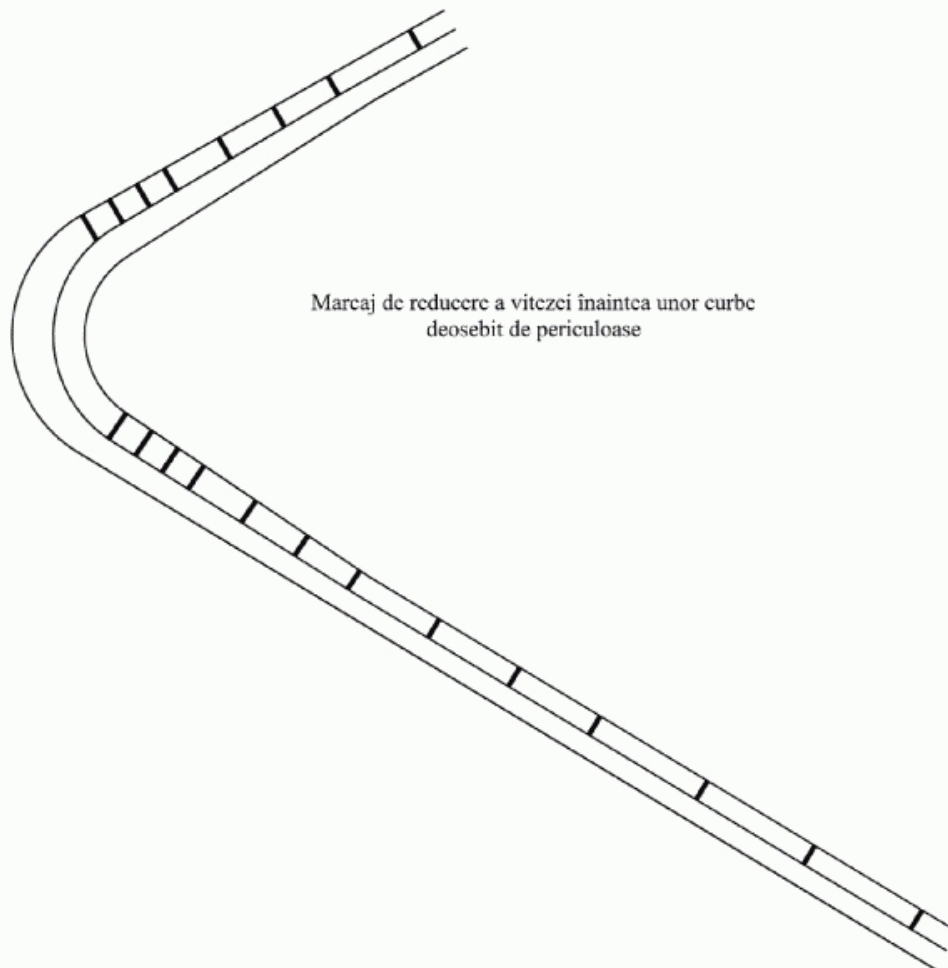





# E-JURIDIC

## d) Laterale

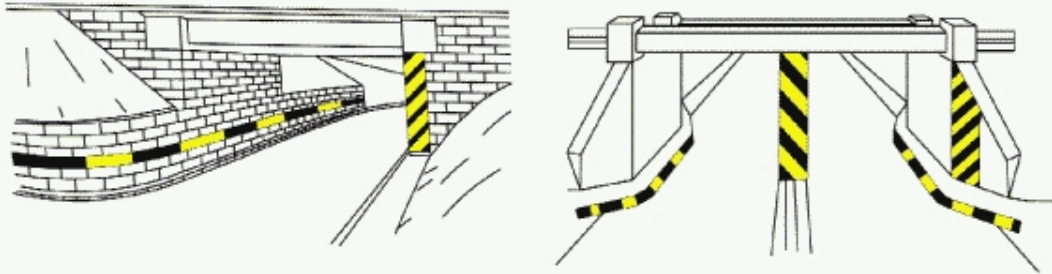

Marcaje pe ziduri de sprijin și pe infrastructurile pasajelor inferioare

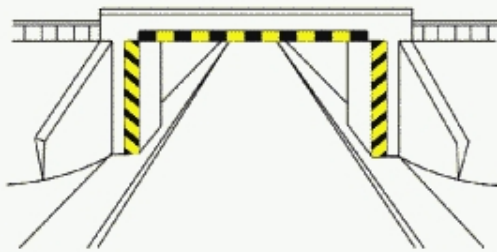

Marcaje la pasaje care nu au asigurat gabaritul de înălțime

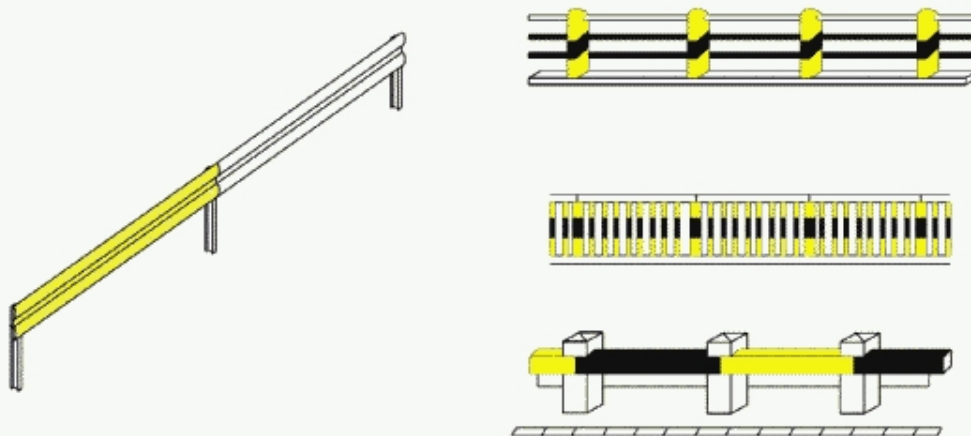

Marcaje pe parapete



# E-JURIDIC

## MARCAJE RUTIERE

### a) Longitudinale



Marcaj de separare a sensurilor de circulație format dintr-o linie discontinuă simplă. Marcaj de delimitare a părții carosabile cu linie discontinuă



Marcaj de separare a sensurilor de circulație format dintr-o linie continuă simplă. Marcaj de delimitare a părții carosabile cu linie discontinuă

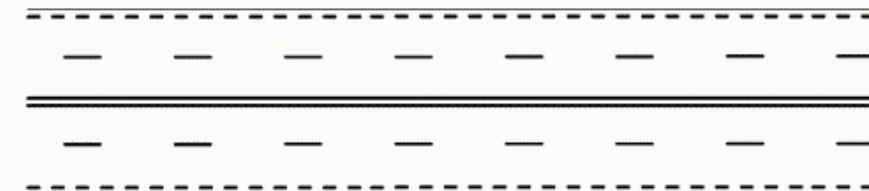

Marcaj de separare a sensurilor de circulație format dintr-o linie continuă dublă. Marcaj de delimitare a benzilor de circulație de același sens cu linie discontinuă. Marcaj de delimitare a părții carosabile cu linie discontinuă

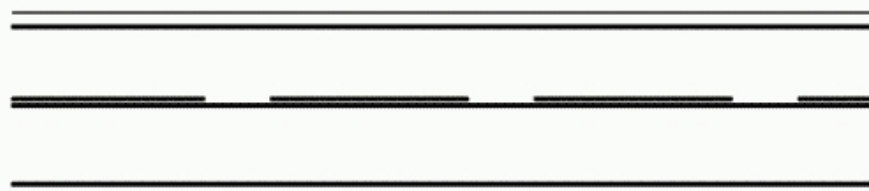

Marcaj de separare a sensurilor de circulație format dintr-o linie continuă, dublată cu una discontinuă. Marcaj de delimitare a părții carosabile cu linie continuă



# E-JURIDIC

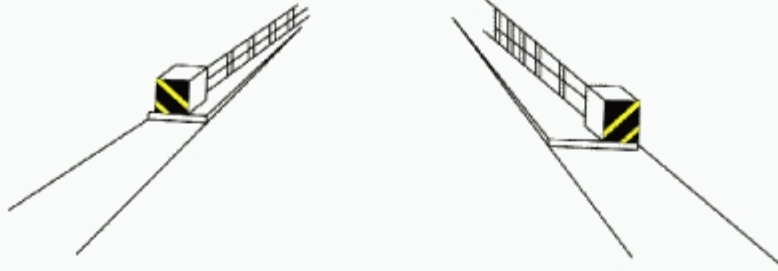

Marcaje pe coronamentele podetelor



Marcaje la refugii pe partea carosabilă

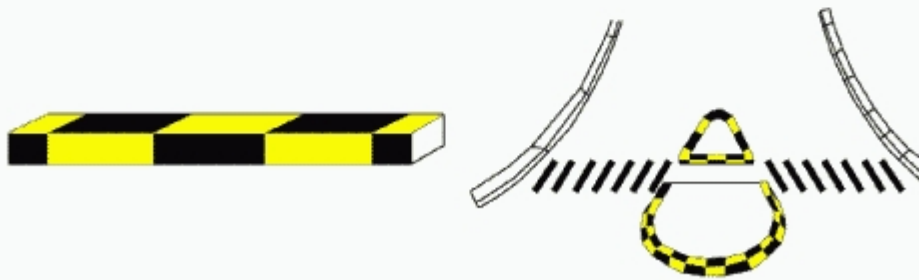

Marcaje pe borduri



# E-JURIDIC

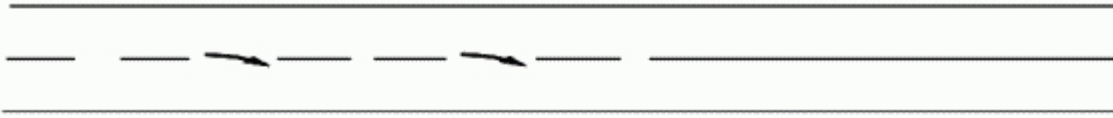

Săgeți de revenire pe banda aferentă sensului de mers



Săgeți de schimbare a benzii de circulație



Marcaje inscripționate pe partea carosabilă



# E-JURIDIC

e) Marcaje temporare pentru semnalizarea lucrărilor în zona drumului public

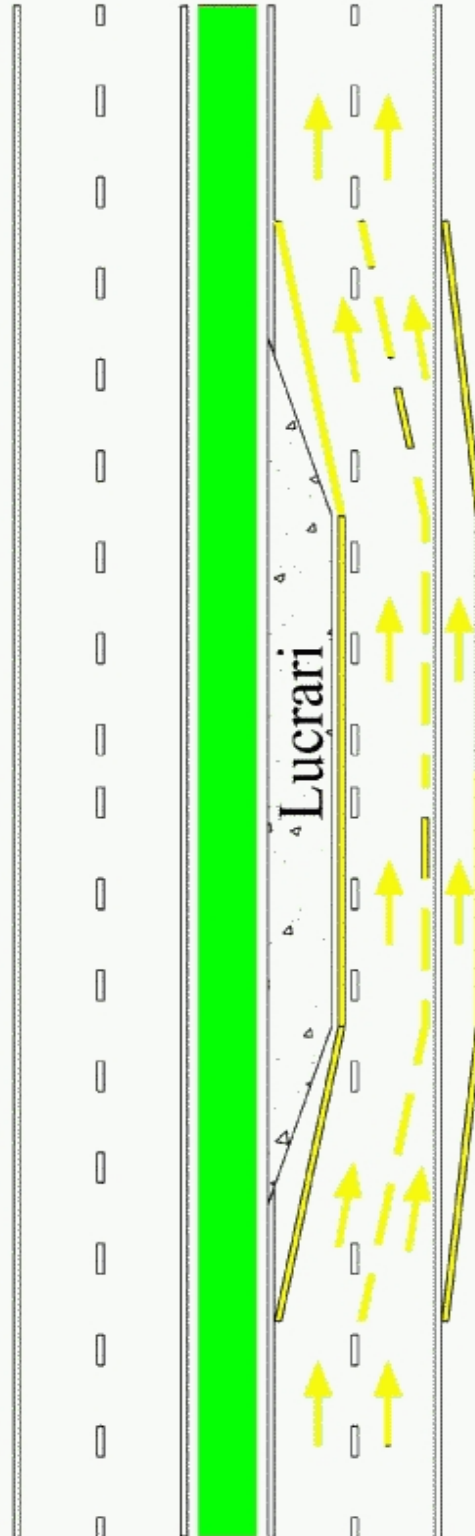



# E-JURIDIC

## SEMNALELE POLIȚISTULUI



Atenție oprire



Oprire



Oprire



Oprire



Oprire



Măriți viteza



Reduceți viteza



# E-JURIDIC

## SEMNALELE POLIȚISTULUI DE PE MOTOCICLETA DE POLIȚIE



Oprire



Reduceți viteza



Oprire

## SEMNALELE POLIȚISTULUI DIN AUTOVEHICULUL DE POLIȚIE



Oprire



# E-JURIDIC

## MESAJE VARIABILE TRANSMISE CU DISPOZITIVE LUMINOASE INSTALATE PE AUTOVEHICULELE DE POLIȚIE



### Mesajele afișate:

1. STOP POLIȚIA
2. ATENȚIE PERICOL
3. CONCURS SPORTIV
4. MENȚINEȚI ORDINEA
5. ELIBERAȚI ZONA
6. ELIBERAȚI BANDA
7. URMAȚI POLIȚIA
8. GABARIT DEPĂȘIT
9. COLOANĂ OFICIALĂ
10. CONTROL POLIȚIA
11. REDUCEȚI VITEZA
12. ATENȚIE BLOCAJ
13. ATENȚIE ACCIDENT
14. CIRCULAȚI





## **E-JURIDIC**

**SEMN DISTINCTIV PENTRU CONDUCĂTORII DE AUTOVEHICULE CU VECHIMEA ÎN CONDUCERE MAI MICĂ DE UN AN**

